

Lift & Slide MLS72 TB

The code "MLS72 TB" stands for an extensive family of thermal barrier lift and slide door solutions in steel, galvanized steel, Cor-Ten steel and stainless steel marine grade AISI 316L. All profiles are cold formed with 2mm thick steel - ideal solution for large glazing with weights up to 600 kg. The 72 mm profile depth is a perfect compromise between design and security. The extremely strong framing material accommodates security glass up to 50 mm and can be automated.

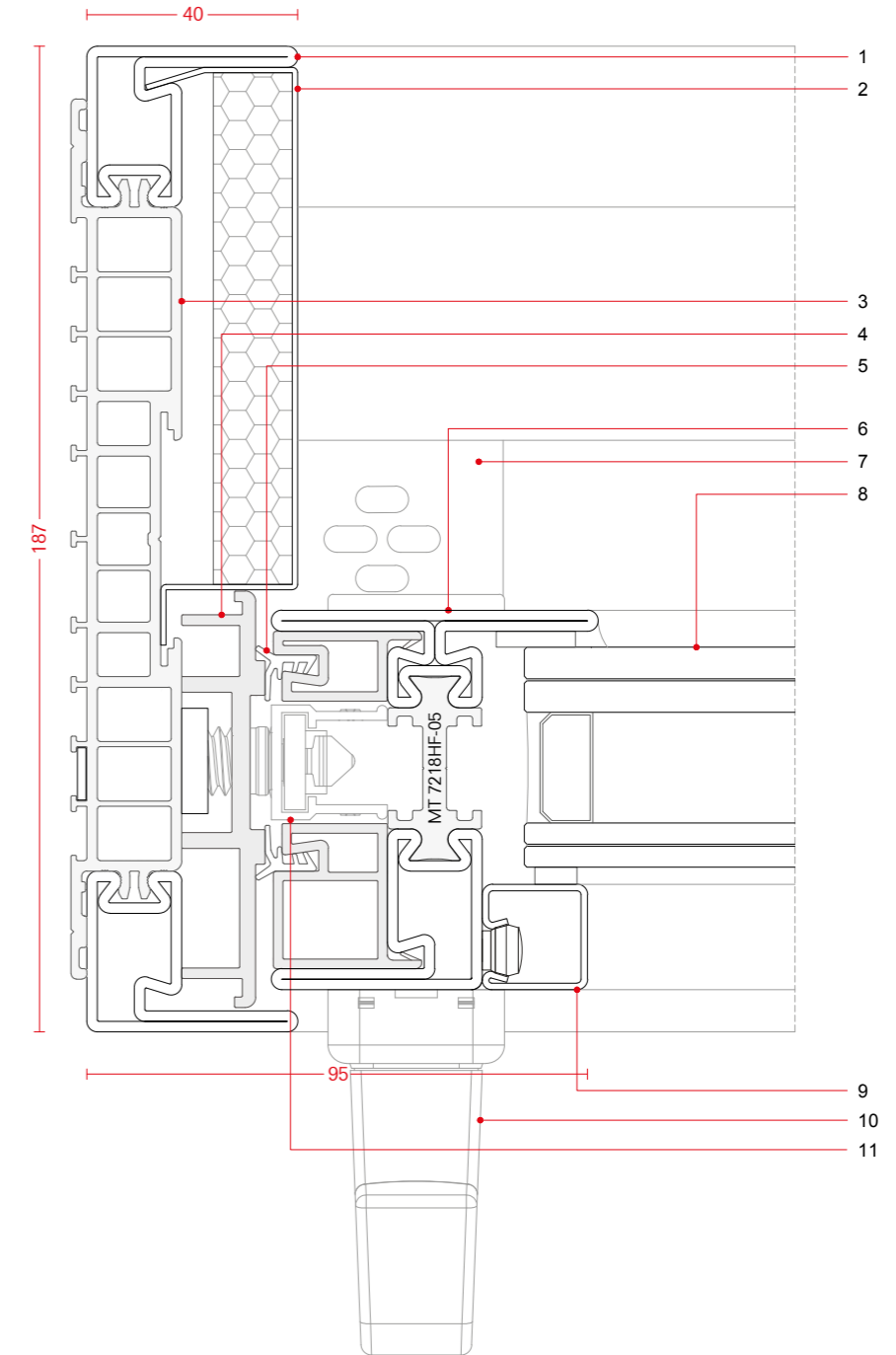

FEATURES

- | | |
|--|--|
| 1. 2 mm tubular profile with extremely high moments of inertia | 7. Water drainage |
| 2. Aesthetic cover cap with insulating material | 8. Profiles accommodate high-performance glazing |
| 3. Thermal barrier in polyamide PA 6.6 | 9. Wide range of square and angular glazing beads |
| 4. Insulated front strike | 10. Manual opening up to 400 Kg and automated up to 600 Kg, single and multiple sliding, pocket solution |
| 5. Mechanically fixed rebate gaskets | 11. Fittings with concealed sliding mechanism |
| 6. Profiles available in galvanized steel, Cor-Ten and stainless steel AISI 316L | |

Lift & Slide MLS72 TB

profile range - bar length 5800 mm

-02 Galvanized steel -05 Stainless steel AISI 316L 2B -07 Cor-Ten steel

profile range - bar length 5800 mm

-02 Galvanized steel -05 Stainless steel AISI 316L 2B -06 Satin stainless steel AISI 316L -07 Cor-Ten steel
-62 PVC -65 ABS

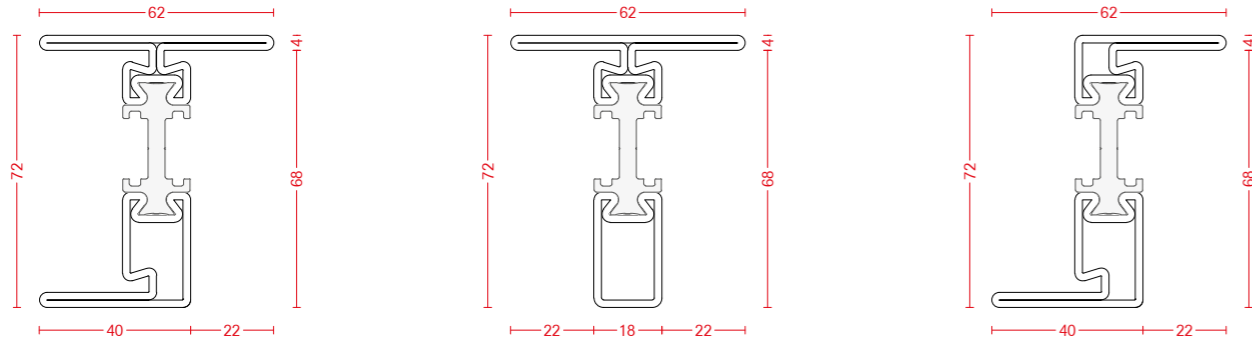

MT 7218HF-02
MT 7218HF-05
MT 7218HF-07

MT 7218TF-02
MT 7218TF-05
MT 7218TF-07

MT 7218ZF-02
MT 7218ZF-05
MT 7218ZF-07

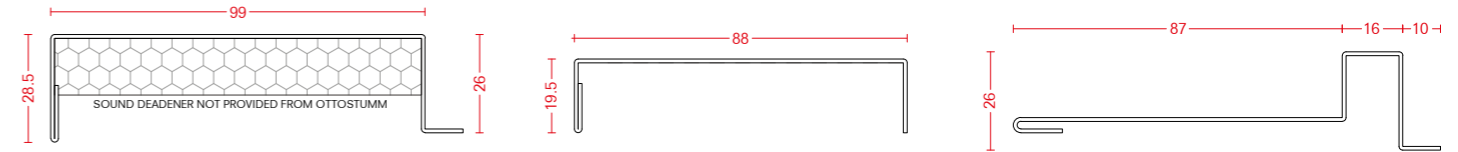

E99403-02
E99403-06 L 3000 mm
E99403-07

E99405-02
E99405-06 L 3000 mm
E99405-07

E99408-02
E99408-06 L 3000 mm
E99408-07

E99404-02 L 4000 mm
E99404-06

E99406-02 L 4000 mm
E99406-06

E99409-02 L 4000 mm
E99409-06

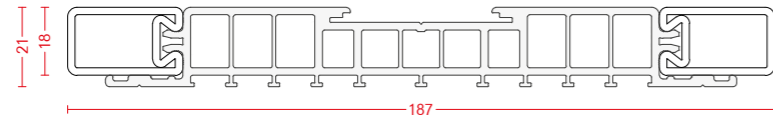

MT 18721CI-05
MT 18721CI-07

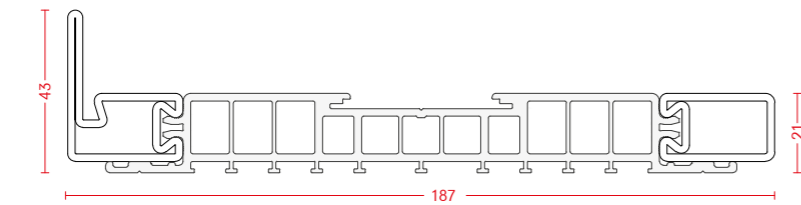

MT 18721CL-02
MT 18721CL-05
MT 18721CL-07

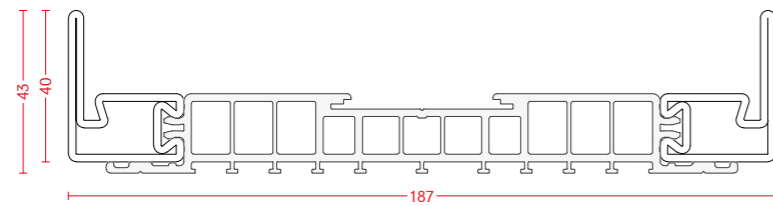

MT 18721CU-02
MT 18721CU-05
MT 18721CU-07



E99407-06
E99407-07
L 3000 mm

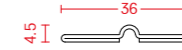

E99401-06
L 4000 mm



E99412-05
L 3000 mm

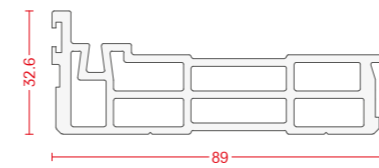

99 8933PL-62

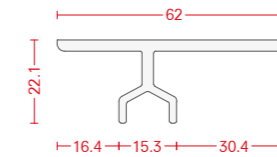

99 6222GU-65

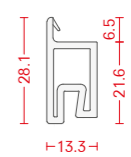

99 2813PG-62

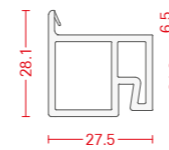

99 2828PG-62

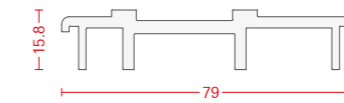

99 7916PL-62

examples

examples

SECTION 1

EXTERNAL

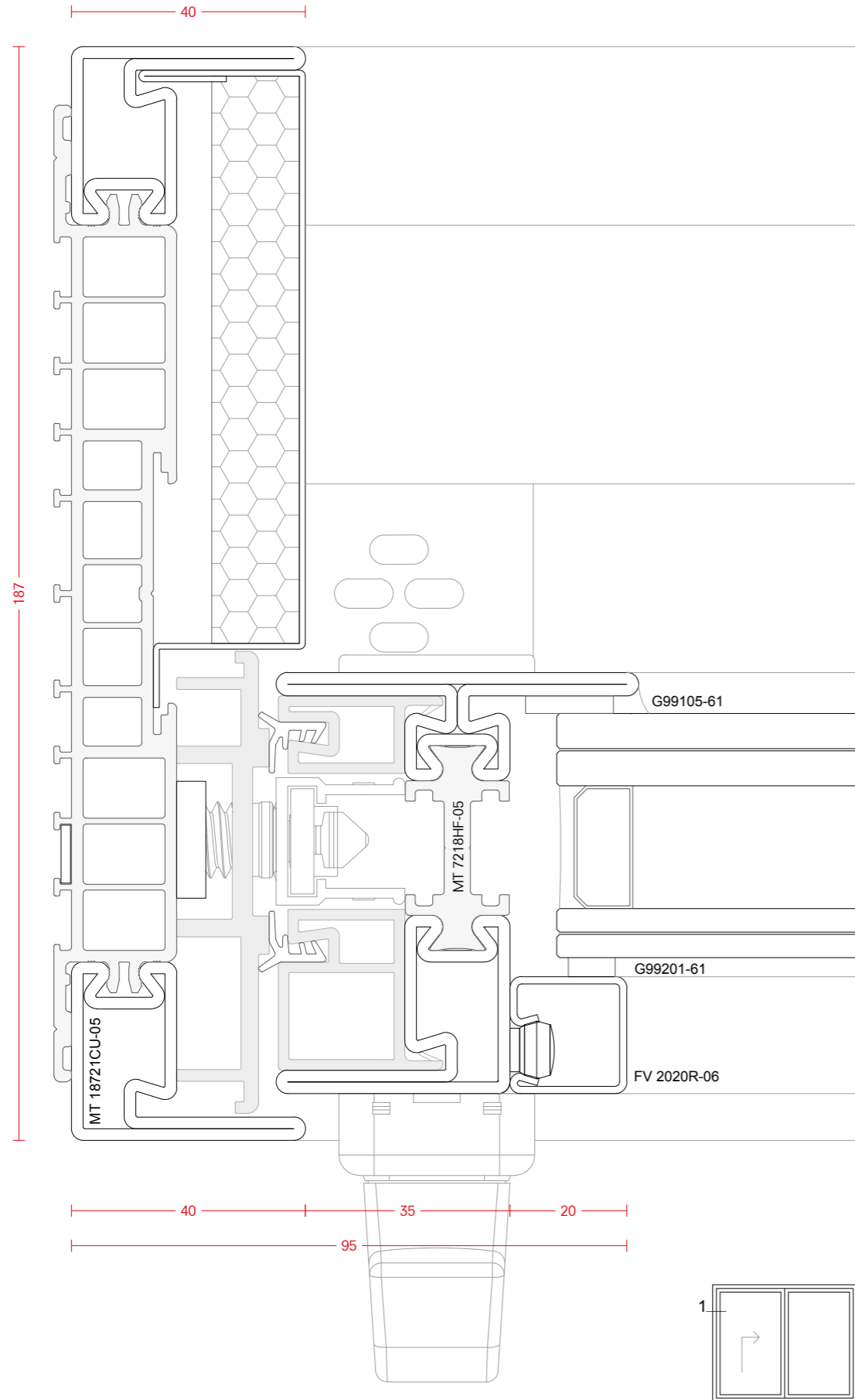

SECTION 2

EXTERNAL

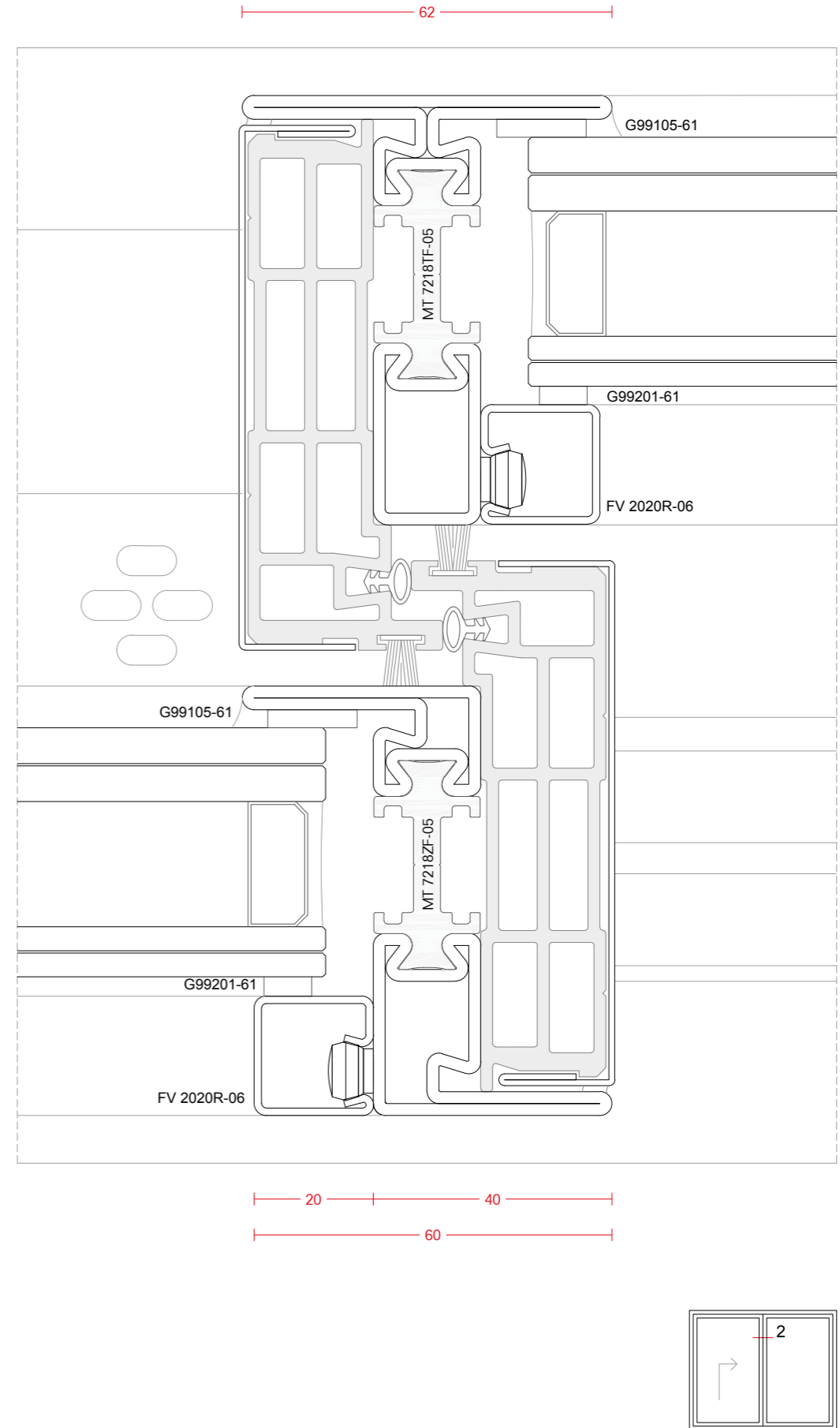

examples

SECTION 3

EXTERNAL

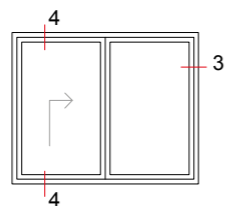
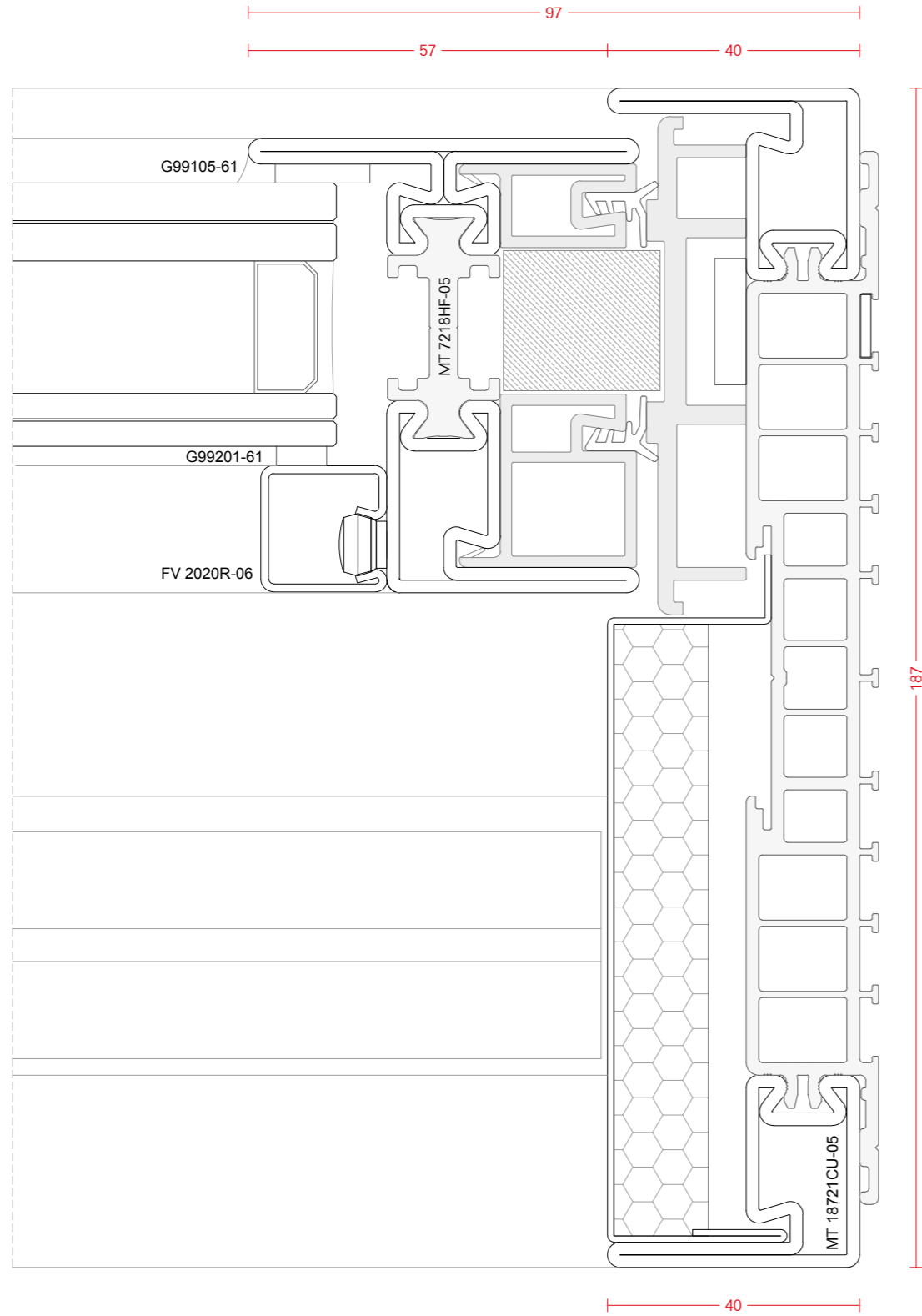

examples

SECTION 4

EXTERNAL

